

I enlarged view

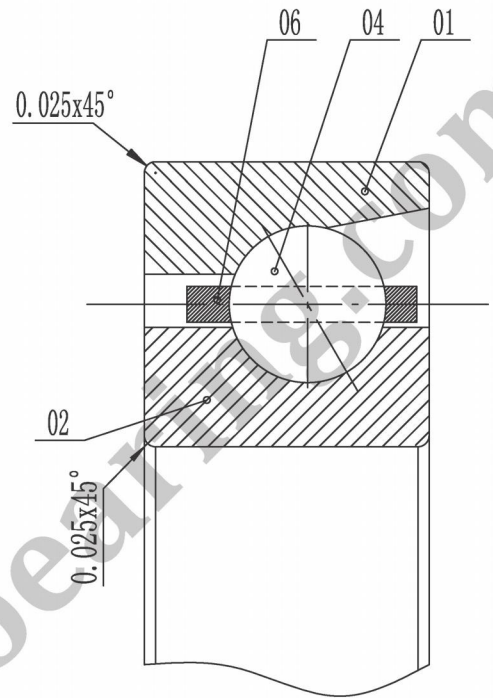

SILVER THIN SECTION BEARING

Formal drawing of SA065AR0 will be submitted after contact with:  
[sales@jcb-bearing.com](mailto:sales@jcb-bearing.com) or [sales@thinsectionbearings.com](mailto:sales@thinsectionbearings.com)

06	cage		nylon			
04	steel ball		AISI 52100 Steel			
02	inner ring	1	AISI 52100 Steel			
01	outer ring	1	AISI 52100 Steel			

No.	designation	qty	material	unit	total	remark
				weight (lbs)		

Luoyang JCB Bearing Technology Co., Ltd  
 Contact information  
 Company Address : No.285 Fenghua road, Luoyang, Henan,China.  
 Postal code : 471000  
 Phone : 0086-379-68611678 Fax : 0086-379-68611679  
 E-mail: [sales@jcb-bearing.com](mailto:sales@jcb-bearing.com)  
 Reserved E-mail: [sales@thinsectionbearings.com](mailto:sales@thinsectionbearings.com)  
 Website: <http://www.jcb-bearing.com>  
<https://www.thinsectionbearings.com>

SA065AR0

weight(lbs)

0.30

total page 1 page 1

Luoyang JCB Bearing Technology Co., Ltd